

1. HEADFRAME TYPE. PLEASE TICK

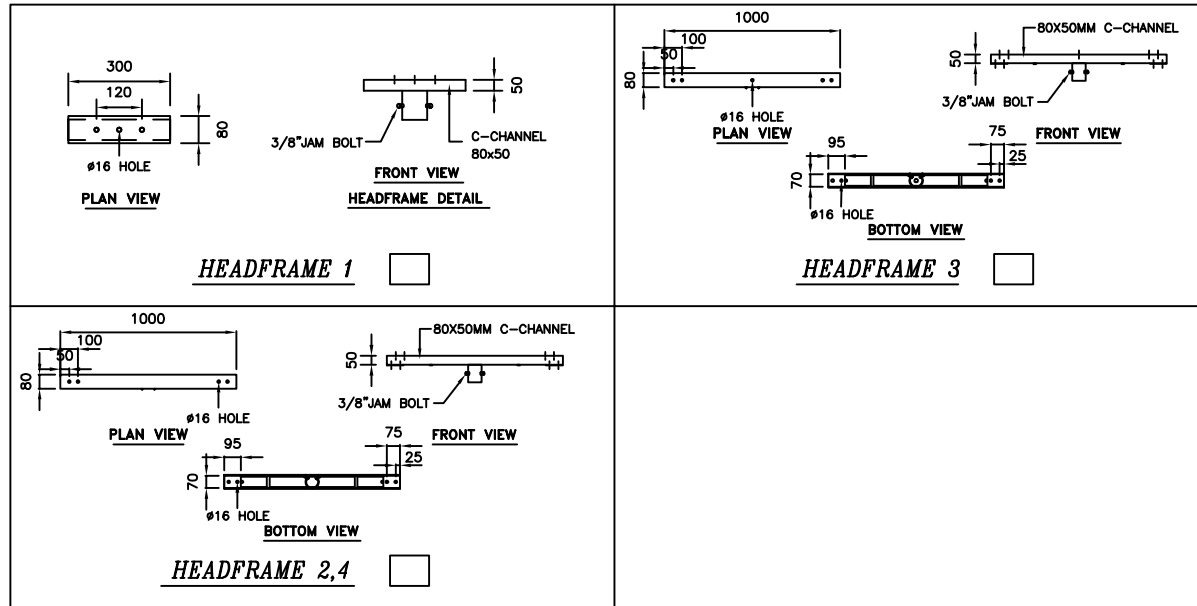

PLEASE TICK

2. SERVICE DOOR TYPE

STEEL	<input type="checkbox"/>
FIBER WITH _____ WORDING	<input type="checkbox"/>

3. SPECIAL DOOR HEIGHT "A"

2.0M FROM GROUND LEVEL	<input type="checkbox"/>
1.8M FROM GROUND LEVEL	<input type="checkbox"/>

4. ANTI-STICK PAINT

_____ M FROM GROUND LEVEL	<input type="checkbox"/>
---------------------------	--------------------------

5. COLUMN DETAIL. PLEASE TICK

TICK	Lm	STANDARD SERVICE DOOR DETAIL				FLANGE DETAIL				HOLDING BOLT		OVERLAP	
		A	B	C	D	SQ	C-C	ELONGATED		ØD	E	1	2
<input checked="" type="checkbox"/>	3	305	305	150	72	250	195	20	35	Ø16	280	-	-
	4	305	305	150	72	250	195	20	35	Ø16	280	-	-
	5	305	305	150	72	250	195	20	35	Ø16	280	-	-
	6	305	305	150	100	300	220	25	45	Ø20	450	150	-
	7	305	305	150	110	300	220	25	45	Ø20	450	150	-
	8	305	450	300	110	300	220	25	45	Ø20	450	150	250
	9	610	450	300	110	300	220	30	50	Ø24	570	150	250
	10	610	450	300	110	335	260	30	50	Ø24	570	150	250
	12	610	450	300	110	400	300	30	50	Ø24	570	150	250

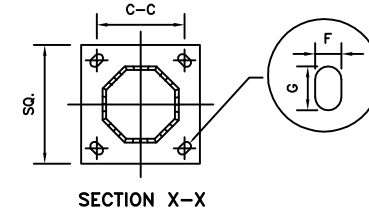
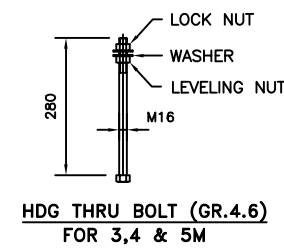
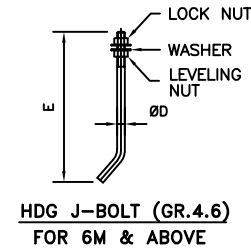
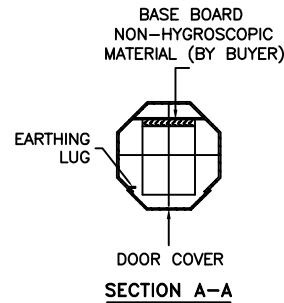
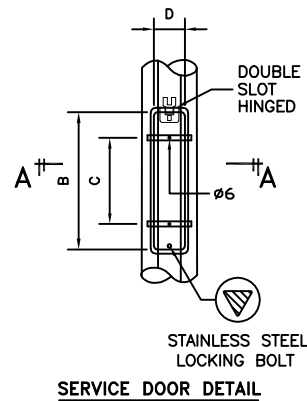
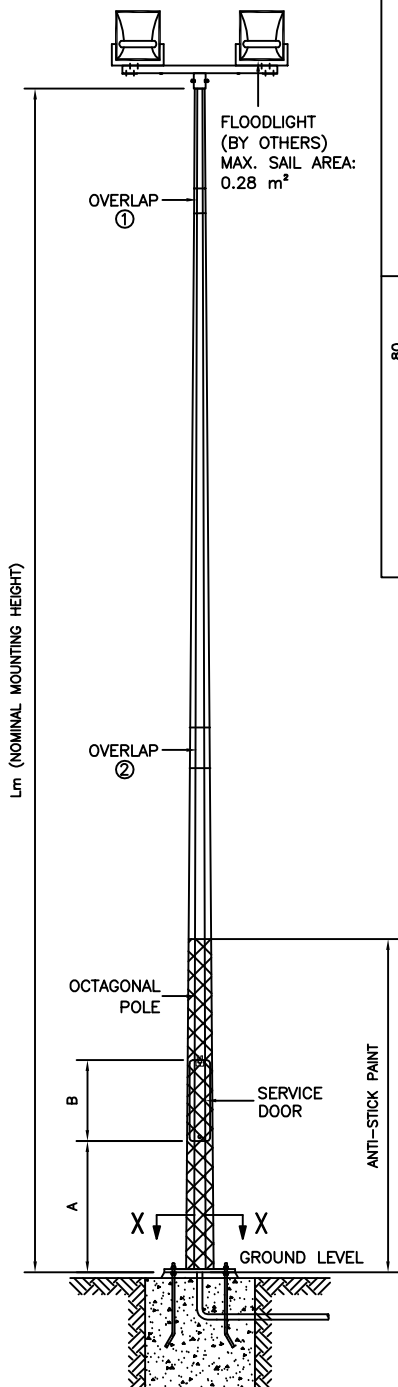

TECHNICAL SPECIFICATIONS

- THE COLUMNS ARE DESIGNED TO WITHSTAND MAXIMUM WIND SPEED OF 35 m/s (3-SEC GUST), TOPOGRAPHY, GROUND ROUGHNESS & STATISTICAL FACTOR OF 1.0.
- COLUMNS ARE MANUFACTURED IN COMPLIANCE TO BRITISH STANDARD BS EN 40.
- MATERIALS USED FOR COLUMNS ARE COMPLIANCE TO BS EN 10025 S275JR.
- COLUMNS ARE LONGITUDINALLY SEAM WELDED CONFORM TO BS 1011-1 BY AUTOMATIC CONTINUOUS METAL INERT GAS (MIG) PROCESS.
- COLUMNS ARE ANTI-CORRODED BY HOT-DIP GALVANIZED, COMPLIANCE TO GALVANIZING STANDARD BS EN ISO 1461
- ALL DIMENSIONS ARE IN (mm), UNLESS OTHERWISE SPECIFIED.
- ALL MATERIAL TOLERANCES ARE ACCORDANCE TO: BS EN 10029 (STEEL PLATE) BS EN 10255 (STEEL TUBE / HOLLOW SQUARE) BS EN 10056 (STEEL ANGLE)
- UNLESS OTHERWISE SPECIFIED, ALL DIMENSION WITHIN THIS DRAWING ARE AS PER GALVAPOLE STANDARD SPECIFICATION AND SUBJECTED TO TOLERANCE AS PER BS EN 40-2.

GALVAPOLE INDUSTRIES SDN. BHD.
 9, JALAN KECAPI 33/2,
 ELITE INDUSTRIAL ESTATE
 JALAN BUKIT KEMUNING,
 40350 SHAH ALAM, SELANGOR
 MALAYSIA
 Tel : +603-51213300
 Fax : +603-51212828
 Website : www.galvapole.com
 Email : sales@galvapole.com

CLIENT : -	CAD FILE : FLC FM STD ISO
PROJECT : -	CHECK BY :
DATE :	DRAWN BY :
DRAWING TITLE : FLOODLIGHT COLUMN FLANGE MOUNTED	APPROVE BY : SCALE : N.T.S REVISION : 00
THIS DRAWING BELONGS TO THE PROPERTY OF GALVAPOLE INDUSTRIES SDN. BHD. IT MUST NOT BE REPRODUCED WITHOUT OWNER'S PRIOR CONSENT IN WRITING.	