

**TECHNICAL SPECIFICATIONS**

- THE COLUMNS ARE DESIGNED TO WITHSTAND WIND SPEED OF 35M PER SECOND, TOPOGRAPHY, GROUND ROUGHNESS & STATISTICAL FACTOR OF 1.0.
- COLUMNS ARE MANUFACTURED IN COMPLIANCE TO BRITISH STANDARD BS EN 40.
- MATERIALS USED FOR LIGHTING COLUMNS ARE COMPLIANCE TO BS EN 10025 S275 /JIS G3101 SS400.
- LIGHTING COLUMNS ARE LONGITUDINALLY SEAM WELDED CONFORM TO BS 5135 BY AUTOMATIC CONTINUOUS METAL INERT GAS (MIG) PROCESS.
- COLUMNS ARE ANTI-CORRODED BY HOT-DIP GALVANIZED, COMPLIANCE TO GALVANIZING STANDARD BS EN ISO 1461
- SERVICE DOOR DIMENSIONS ARE GIVEN AS A GUIDE ONLY. THE ENGINEER MUST SATISFY HIMSELF THAT DIMENSIONS GIVEN ARE ADEQUATE FOR THE INSTALLATION OF THE REQUIRED CONTROL GEAR.
- ALL DIMENSIONS ARE IN (mm), UNLESS OTHERWISE SPECIFIED.

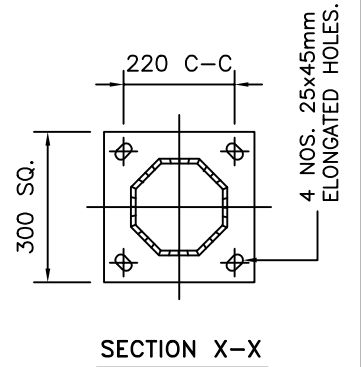

**GALVAPOLE INDUSTRIES SDN. BHD.**

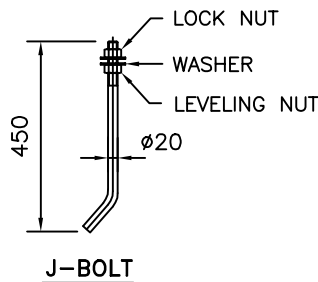
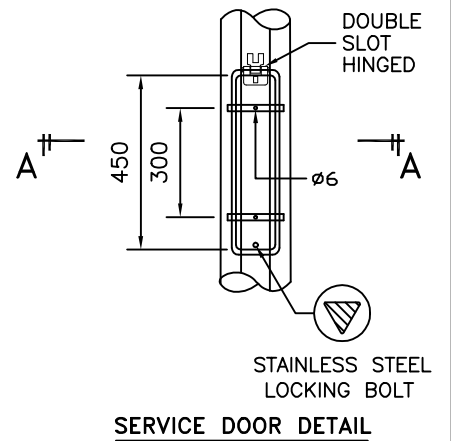
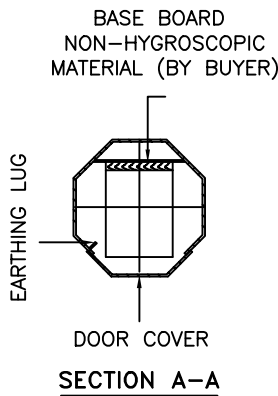
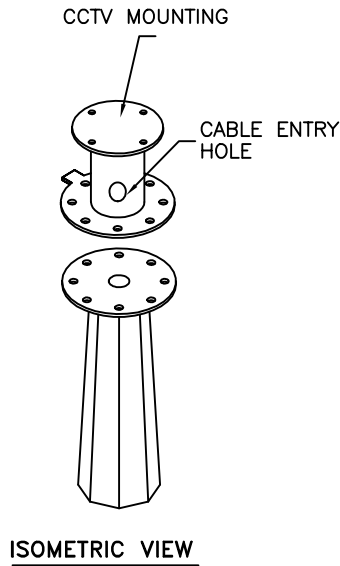
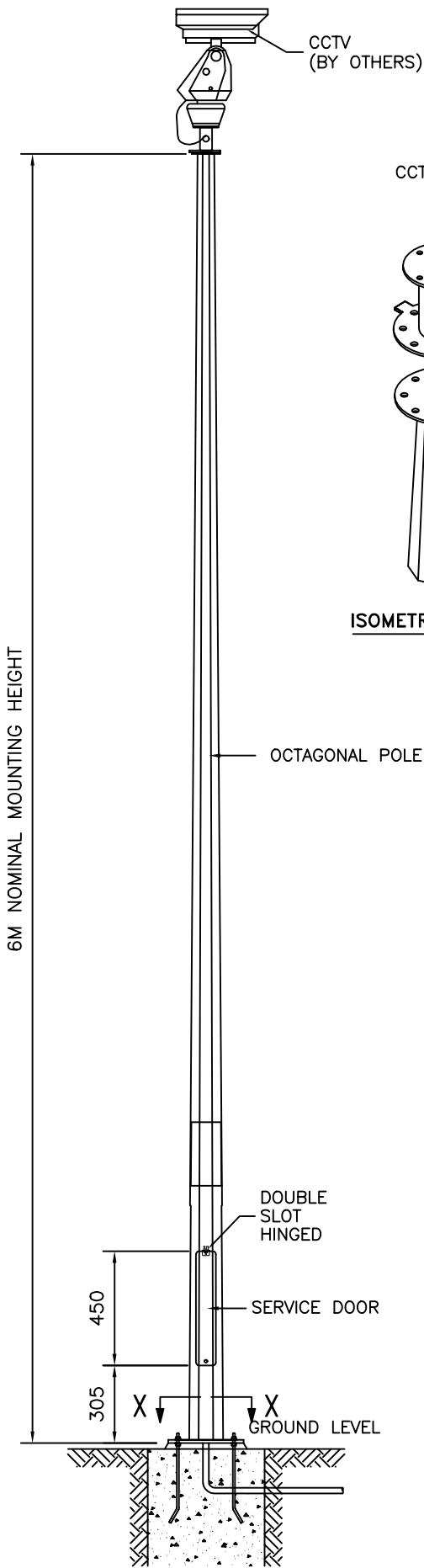

9, JALAN KECAPI 33/2,  
ELITE INDUSTRIAL ESTATE  
JALAN BUKIT KEMUNING,  
40350 SHAH ALAM, SELANGOR  
MALAYSIA  
Tel : 603-51213300  
Fax : 603-51212828  
Website : www.galvapole.com  
Email : sales@galvapole.com

CLIENT : -		DRAW NO : 6M/CCTV/FM/R0	
PROJECT : -		FILE NAME : CCTV STD ISO	
DATE : 17-03-2010	DRAWN BY : A.D	CHECKED BY : CCC	SCALE : N.T.S
DRAWING TITLE :		APPROVED BY : CCC	A4 SIZE
<b>6M CCTV POLE FM</b>		THIS DRAWING IS THE PROPERTY OF GALVAPOLE INDUSTRIES SDN. BHD. AND MUST NOT BE REPRODUCED WITHOUT THEIR PRIOR CONSENT IN WRITING.	