

TECHNICAL SPECIFICATIONS

- THE COLUMNS ARE DESIGNED TO WITHSTAND WIND SPEED OF 35M PER SECOND, TOPOGRAPHY, GROUND ROUGHNESS & STATISTICAL FACTOR OF 1.0.
- COLUMNS ARE MANUFACTURED IN COMPLIANCE TO BRITISH STANDARD BS EN 40.
- MATERIALS USED FOR LIGHTING COLUMNS ARE COMPLIANCE TO BS EN 10025 S275 /JIS G3101 SS400.
- LIGHTING COLUMNS ARE LONGITUDINALLY SEAM WELDED CONFORM TO BS 5135 BY AUTOMATIC CONTINUOUS METAL INERT GAS (MIG) PROCESS.
- COLUMNS ARE ANTI-CORRODED BY HOT-DIP GALVANIZED, COMPLIANCE TO GALVANIZING STANDARD BS EN ISO 1461
- SERVICE DOOR DIMENSIONS ARE GIVEN AS A GUIDE ONLY. THE ENGINEER MUST SATISFY HIMSELF THAT DIMENSIONS GIVEN ARE ADEQUATE FOR THE INSTALLATION OF THE REQUIRED CONTROL GEAR.
- ALL DIMENSIONS ARE IN (mm), UNLESS OTHERWISE SPECIFIED.

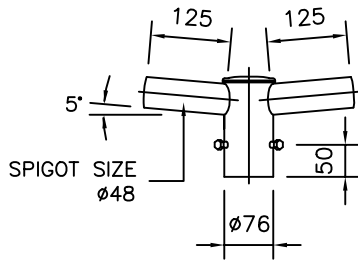
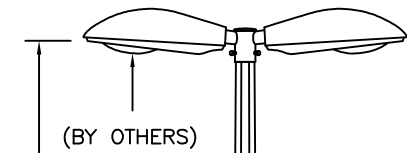

DOUBLE SHORT ARM

8M NOMINAL MOUNTING HEIGHT

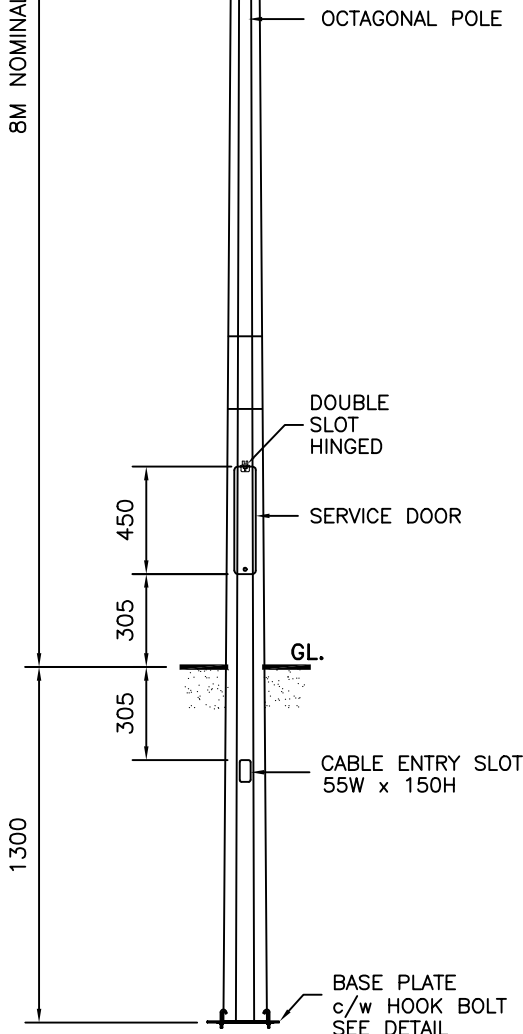

BASE BOARD
NON-HYGROSCOPIC
MATERIAL (BY BUYER)

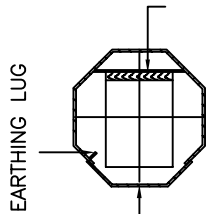

SECTION A-A

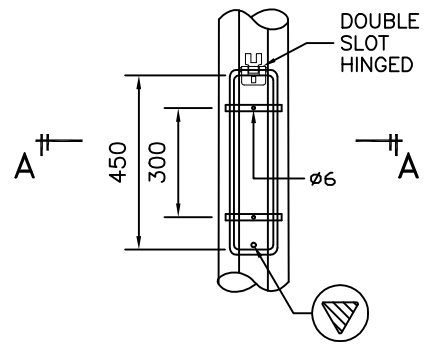

SERVICE DOOR DETAIL

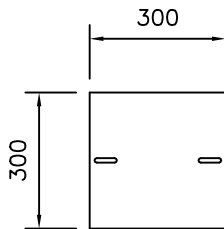

BASE PLATE

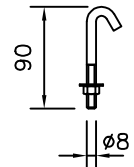

HOOK BOLT

GALVAPOLE INDUSTRIES SDN. BHD.



9, JALAN KECAPI 33/2,
ELITE INDUSTRIAL ESTATE
JALAN BUKIT KEMUNING,
40350 SHAH ALAM, SELANGOR
MALAYSIA
Tel : 603-51213300
Fax : 603-51212828
Website : www.galvapole.com
Email : sales@galvapole.com

CLIENT : -		DRAW NO : 8M/SLC/DSA/PT/R0	
PROJECT : -		FILE NAME : SLC STD ISO	
DATE : 17-03-2010	DRAWN BY : A.D	CHECKED BY : CCC	SCALE : N.T.S
DRAWING TITLE :		APPROVED BY : CCC	A4 SIZE
8M STREET LIGHTING COLUMN DOUBLE SHORT ARM PT			

THIS DRAWING IS THE PROPERTY OF GALVAPOLE INDUSTRIES SDN. BHD. AND MUST NOT BE REPRODUCED WITHOUT THEIR PRIOR CONSENT IN WRITING.