

TECHNICAL INFORMATION

| | | |
|-------------------------|---|--------------------------------|
| COLUMN DESIGN | : | ILE TR7./ BS-CP3 |
| MATERIAL | : | BS 4360 G50A / JIS G3101 SS400 |
| BASIC WIND SPEED | : | 35 m/s |
| TOPOGRAPHY FACTOR | : | 1 |
| TERRAIN CATERGORY | : | 2 |
| EXPOSURE PERIOD | : | 25 YEARS |
| WELDING CONFORMS TO | : | BS 5135 |
| GALVANIZING CONFORMS TO | : | BS 729 |

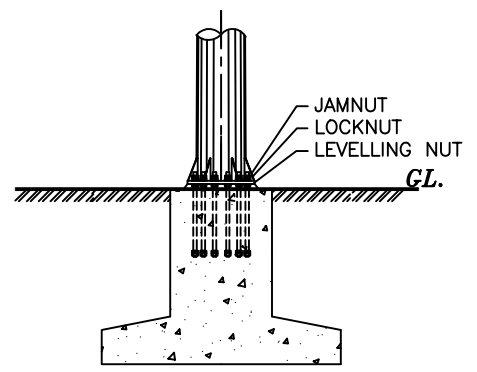
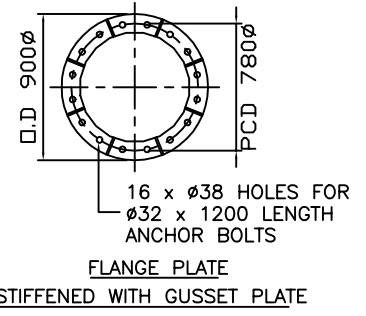
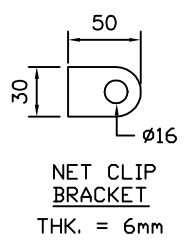
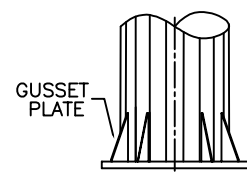
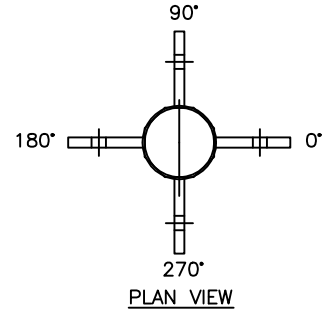
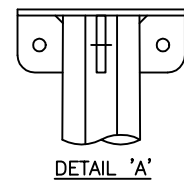

GALVAPOLE INDUSTRIES SDN. BHD.

 9, JALAN KECAPI 33/2,
 ELITE INDUSTRIAL ESTATE
 JALAN BUKIT KEMUNING,
 40350 SHAH ALAM, SELANGOR
 MALAYSIA
 Tel : 603-51213300
 Fax : 603-51212828
 Website : www.galvapole.com
 Email : sales@galvapole.com

| | | | |
|---|----------------|---------------------------|---------------|
| CLIENT : - | | DRAW NO : 35M/NP/FM/01/R0 | |
| PROJECT : - | | FILE NAME : NP ISO STD | |
| DATE : 15-09-2010 | DRAWN BY : A.D | INCHARGE BY : CCC | SCALE : N.T.S |
| DRAWING TITLE : 35M NETTING POLE FM | | CHECK/APPR. BY : CCC | A4 SIZE |

THIS DRAWING IS THE PROPERTY OF GALVAPOLE INDUSTRIES SDN. BHD. AND MUST NOT BE REPRODUCED WITHOUT THEIR PRIOR CONSENT IN WRITING.