

**TECHNICAL SPECIFICATIONS**

- THE COLUMNS ARE DESIGNED TO WITHSTAND WIND SPEED OF 35M PER SECOND, TOPOGRAPHY, GROUND ROUGHNESS & STATISTICAL FACTOR OF 1.0.
- COLUMNS ARE MANUFACTURED IN COMPLIANCE TO BRITISH STANDARD BS EN 40.
- MATERIALS USED FOR LIGHTING COLUMNS ARE COMPLIANCE TO BS EN 10025 S275 /JIS G3101 SS400.
- LIGHTING COLUMNS ARE LONGITUDINALLY SEAM WELDED CONFORM TO BS 5135 BY AUTOMATIC CONTINUOUS METAL INERT GAS (MIG) PROCESS.
- COLUMNS ARE ANTI-CORRODED BY HOT-DIP GALVANIZED, COMPLIANCE TO GALVANIZING STANDARD BS EN ISO 1461
- SERVICE DOOR DIMENSIONS ARE GIVEN AS A GUIDE ONLY. THE ENGINEER MUST SATISFY HIMSELF THAT DIMENSIONS GIVEN ARE ADEQUATE FOR THE INSTALLATION OF THE REQUIRED CONTROL GEAR.
- ALL DIMENSIONS ARE IN (mm), UNLESS OTHERWISE SPECIFIED.

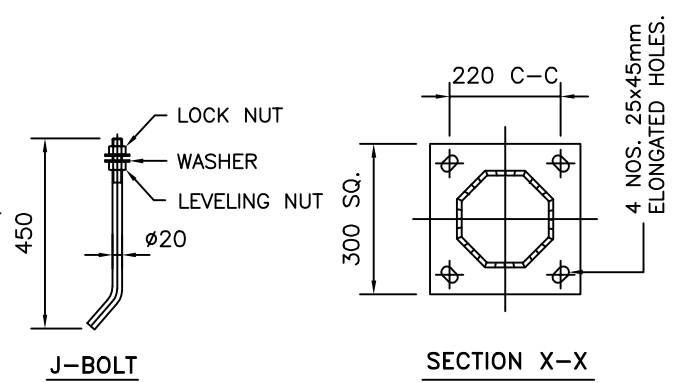
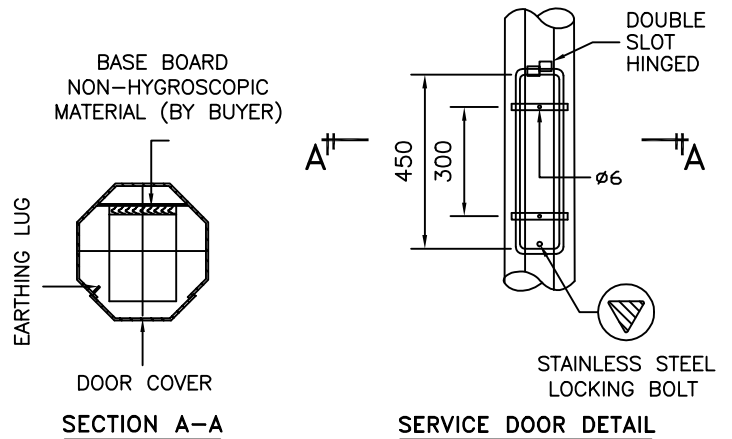

**GALVAPOLE INDUSTRIES SDN. BHD.**  
 9, JALAN KECAPI 33/2,  
 ELITE INDUSTRIAL ESTATE  
 JALAN BUKIT KEMUNING,  
 40350 SHAH ALAM, SELANGOR  
 MALAYSIA  
 Tel : 603-51213300  
 Fax : 603-51212828  
 Website : www.galvapole.com  
 Email : sales@galvapole.com

CLIENT : -  
 PROJECT : -  
 DATE : 01-01-2010    DRAWN BY : A.D  
 DRAWING TITLE :  
**8M STREET LIGHTING COLUMN  
 DOUBLE ARM 1.5M FM**

DRAW NO : 8M/SLC/DA1.5/FM/R0  
 FILE NAME : SLC STD ISO  
 CHECKED BY : CCC    SCALE : N.T.S  
 APPROVED BY : CCC    A4 SIZE  
 THIS DRAWING IS THE PROPERTY OF GALVAPOLE INDUSTRIES SDN. BHD. AND MUST NOT BE REPRODUCED WITHOUT THEIR PRIOR CONSENT IN WRITING.